

Varenummer: 3901150023300
 Beskrivelse: Snekkegear med fri indgangsaksel
 VF 150V-23-HS

Mål

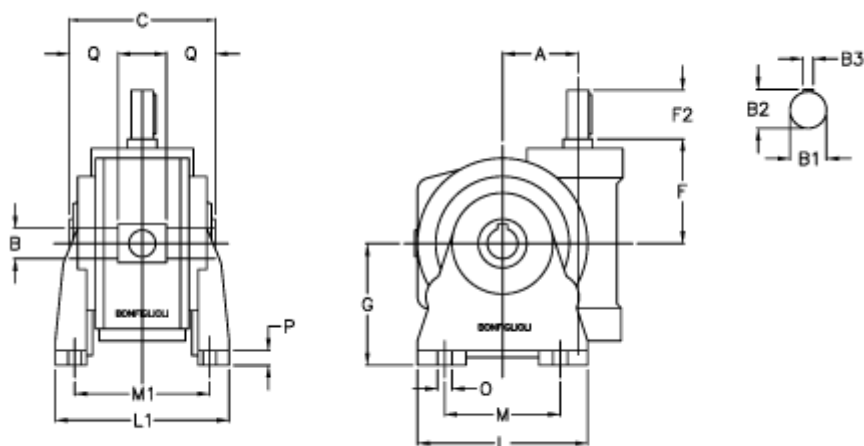

a	= 150.0	F2	= 65	Q	= 55.0
B	= 50	g	= 220		
B1	= 35	L	= 330		
B2	= 38.0	L1	= 260		
B3	= 10	m	= 240		
Betegnelse	= VF 150V-xx-HS	M1	= 211.0		
C	= 175	O	= 18.0		
F	= 185.0	P	= 20		